

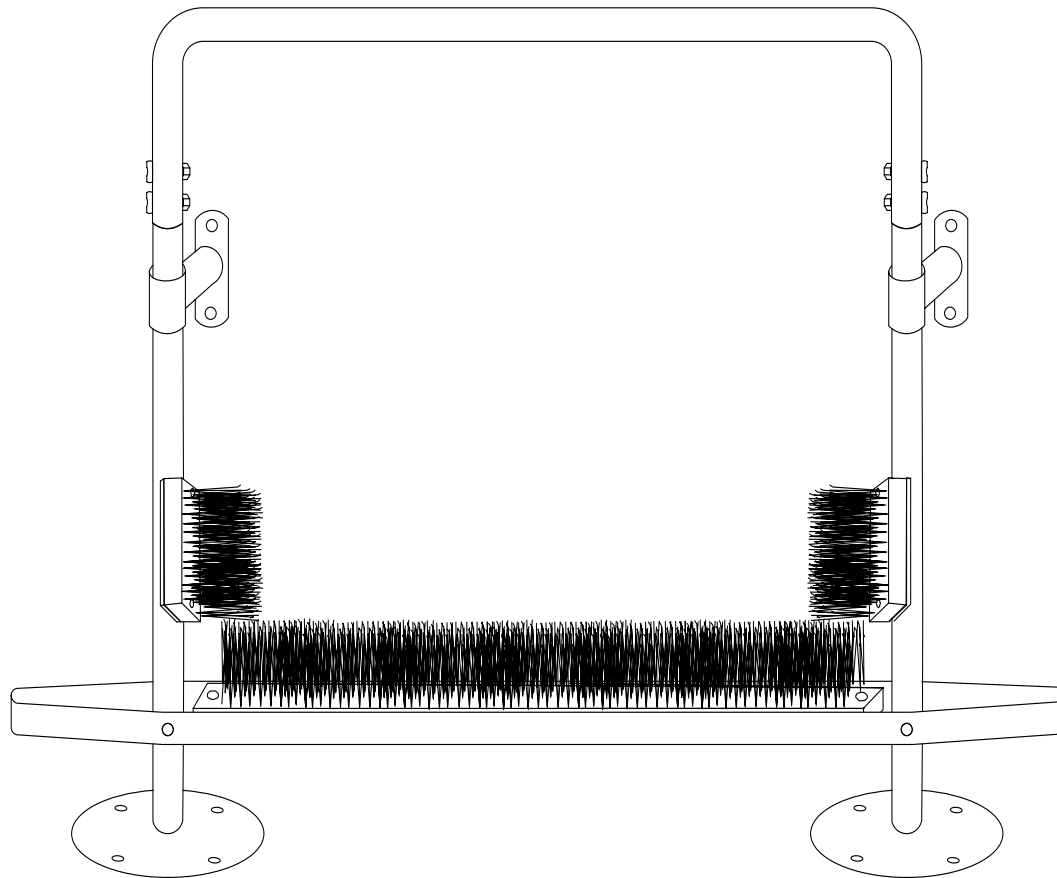





# NET WORLD SPORTS»

## Single Boot wiper

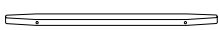

PART	COMPONENT	QTY
UPRIGHT		2
HANDLE BAR		1
BRUSH HOLDER		1
FIXING PLATE		2
WALL FIXING		2
LARGE BRUSH		1
SMALL BRUSH		2
TOOLS, NUTS AND BOLTS		1

## ASSEMBLY INSTRUCTIONS

- STEP 1:** Attach large brush to brush holder using nuts and bolts provided.
- STEP 2:** Feed uprights through brush holder ensuring fixing holes align, loosely secure in place using nuts and bolts provided.
- STEP 3:** Attach small brushes to Uprights using fixing plate between the brush and upright, secure using nuts and bolts provided.
- STEP 4:** If you wish to fix the boot wiper to a wall you should slide one wall fixing over each of the uprights at this point.
- STEP 5:** Attach handle bar to uprights using 2 bolts on each side. Once the frame is assembled tighten all nuts and bolts.

**NET WORLD SPORTS»**

Net World Sports USA

[www.networldsports.com](http://www.networldsports.com)

[cs@networldsports.com](mailto:cs@networldsports.com)

1-866-861-9095

**NET WORLD SPORTS»**

Net World Sports UK

[www.networldsports.co.uk](http://www.networldsports.co.uk)

[cs@networldsports.co.uk](mailto:cs@networldsports.co.uk)

+44 (0) 1691 683 807

- Please report any missing or damaged parts immediately.
- Do not climb or swing on the boot wiper.
- The boot wiper should be checked periodically for damage, wear and tear.
- The boot wiper should be fitted to the ground by a competent person using due diligence and risk assessment.
- Net World Sports will not be responsible for injury or damage caused by a poorly fitted boot wiper.

