

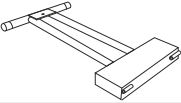





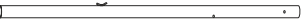
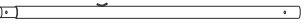

# VERMONT

## Badminton/ Volleyball combi post assembly instructions

ITEM	COMPONENT	QTY
BASE		2
POST SUPPORT		2
TOP POST		2
BOTTOM POST		2
WHEEL		4
1.5 INCH BOLT		4
KNOB		2
2.5 INCH BOLT, NUT, DOME.		4
WRENCH & KEY		1 set

Step 1: Unscrew bolt from post support 

Step 2: Attach post support to base with same bolt.  
Attach wheels to base using 1.5inch bolts.

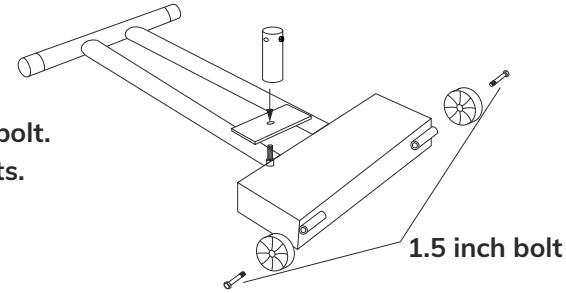

Step 2: Insert top post into bottom post and secure with 2.5inch bolt, nut and dome. Insert assembled post into post support with the cleat facing away from the playing area. secure in place by inserting 2.5 inch bolt through the post and screwing bolt tight. Then screw on dome cap. To anchor post firmly in place screw Knob through post support to clamp post.

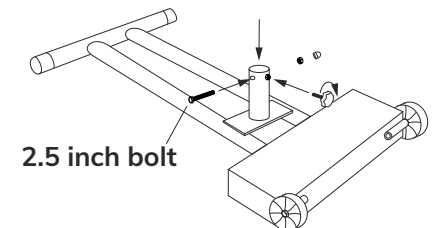
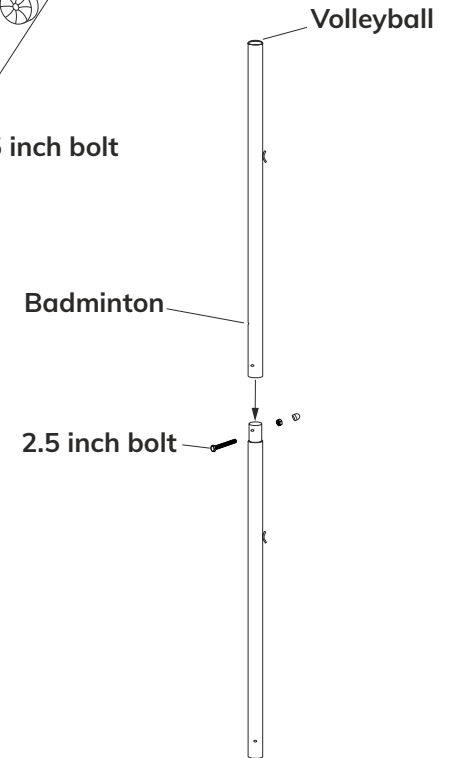

### NET WORLD SPORTS»

Net World sports UK  
[www.networld-sports.co.uk](http://www.networld-sports.co.uk)  
[sales@networld-sports.co.uk](mailto:sales@networld-sports.co.uk)  
 +44 1691 683 807

Net World sports USA  
[www.networld-sports.com](http://www.networld-sports.com)  
[sales@networld-sports.com](mailto:sales@networld-sports.com)  
 1-866-861-9095

**SAFETY:** Please read through instructions before assembling.  
 Please check all parts are present with no defects prior to assembly.  
 Take extreme care when moving/lifting posts.  
 Regularly check equipment to ensure it is safe to use  
 DO NOT climb or swing on posts or net.

# NET WORLD SPORTS»

## ASSEMBLY INSTRUCTIONS VOLLEY BALL AND BADMINTON COMBI POST

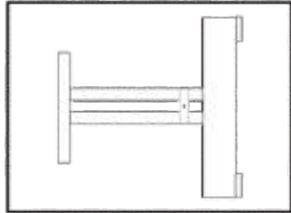

2-Base

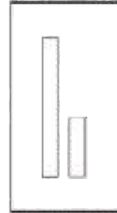

2 Pipe Small  
2 Pipe Large

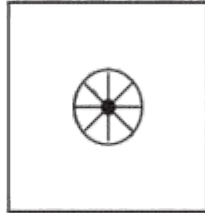

4 Wheel

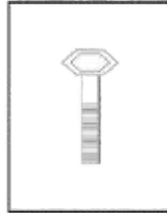

4 Bolt  
1.5" inch

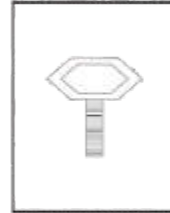

2 Nob

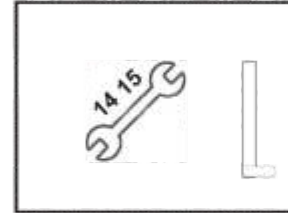

1 Key  
1 L Key

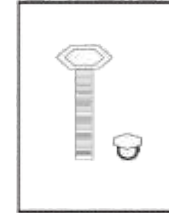

2 Bolt & Dome Nut  
2.5" inch

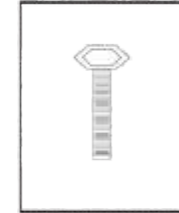

2 L Bolt

